

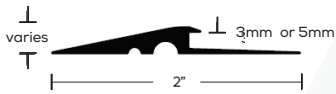

# FUTURA LVT TRIMS & TRANSITIONS

## STOCKING PROGRAM

### LVT TO BARE FLOOR



FINISH: EN  
 SIZE: 3mm - LVT 113  
 COL402069  
 SIZE: 5mm - LVT 115  
 COL402066

### LVT TRACKLESS T-MOLDING

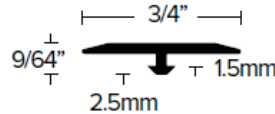

FINISH: EN  
 SIZE: 2.5mm - LVT 102  
 COL402075

### LVT NO-LIP RAMP REDUCER

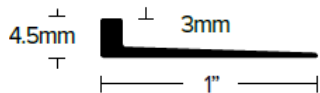

FINISH: MF  
 SIZE: 4.5mm to 3mm  
 - LVT 125  
 COL402021

### LVT INSIDE COVE

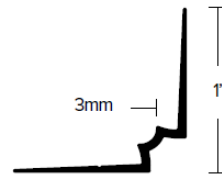

FINISH: EN  
 SIZE: 3mm - LVT 330  
 COL402016

### LVT TO CARPET TILE

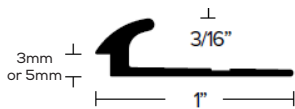

FINISH: EN  
 SIZE: 3mm - LVT 130  
 COL402001  
 SIZE: 5mm - LVT 150  
 COL402004

### LVT NO-LIP STAIR NOSING

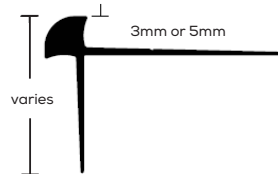

FINISH: EN  
 SIZE: 3mm - LVT 340  
 COL402019  
 SIZE: 5mm - LVT 341  
 COL402047

### CARPET TILE TO LVT/BARE FLOOR

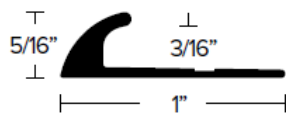

FINISH: EN  
 SIZE: 5/16 - LVT 160  
 COL402007

### LVT BULLNOSE STAIR NOSE

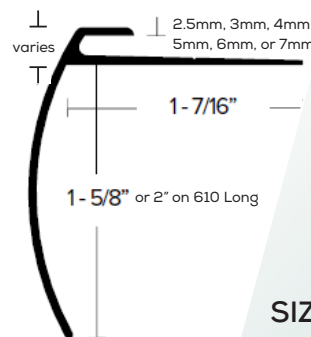

FINISH: EN  
 SIZE: 2.5mm - LVT 625  
 COL402038  
 SIZE: 3mm - LVT 630  
 COL402041  
 SIZE: 4mm - LVT 606  
 COL401177  
 SIZE: 5mm - LVT 608  
 COL389143  
 SIZE: 5mm - LVT 610 LONG  
 COL401179  
 SIZE: 6mm - LVT 604  
 COL401198  
 SIZE: 7mm - LVT 612  
 COL402044

### LVT BEVEL CAP

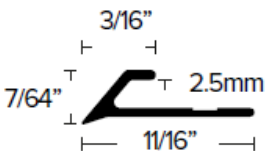

FINISH: EN  
 SIZE: 2.5mm - LVT 425  
 COL402023

### LVT SQUARE CAP

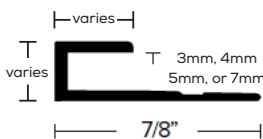

FINISH: EN  
 SIZE: 3mm - LVT 906  
 COL402032  
 SIZE: 4mm - LVT 904  
 COL403264  
 SIZE: 5mm - LVT 905  
 COL403261  
 SIZE: 7mm - LVT 907  
 COL402035

**FUTURA**  
**TRANSITIONS**  
 BY BONNELL ALUMINUM

**FINISH CODES:**  
 EN- Etched Aluminum  
 MF- Mill Finish